

## **AXIS Camera Station S2208 Mk II Appliance**

**User manual**

# AXIS Camera Station S2208 Mk II Appliance

## Table of Contents

---

<b>Get started</b> .....	3
<b>Install your device</b> .....	4
Setup examples .....	4
<b>Configure your device</b> .....	7
Initial Axis recorder setup .....	7
Log in to the server .....	7
Configure AXIS Camera Station Pro .....	8
License a system online .....	11
License a system that's offline .....	11
<b>Manage Windows® user accounts</b> .....	13
Create a user account .....	13
Create an administrator account .....	13
Create a local user group .....	13
Delete a user account .....	13
Change a user account's password .....	14
Create a password reset disk for a user account .....	14
<b>Manage AXIS Camera Station Pro user accounts</b> .....	15
Configure user permissions .....	15
Add users or groups .....	15
User or group privileges .....	16
<b>Manage your device</b> .....	19
Update Windows® .....	19
Configure Windows® update settings .....	19
Add additional storage .....	20
<b>Manage the built-in switch</b> .....	22
About the built-in switch .....	22
Log in to the switch's management page .....	22
Running configuration .....	22
Overview .....	22
Power management .....	23
Network overview .....	25
Settings .....	26
Maintenance .....	27
Logs .....	28
<b>Specifications</b> .....	30
Product overview .....	30
Front and rear .....	30
LED indicators .....	30
<b>Troubleshooting</b> .....	32
Reset your server .....	32
Perform a system recovery .....	32
Troubleshoot AXIS Camera Station Pro .....	33
<b>Need more help?</b> .....	34
Useful links .....	34
Contact support .....	34

# AXIS Camera Station S2208 Mk II Appliance

## Get started

---

### Get started

The standard workflow to configure an AXIS Camera Station Pro recording server is:

- 1.
2. Initial Windows® setup: After installing your device, you are guided through a few steps to set up the region, language, keyboard layout, an administrator account and its password.
3. Initial Axis recorder setup: After the initial Windows® setup, AXIS Recorder Toolbox is opened and you are guided through a few steps to set up basic and necessary settings, for example, computer name, date and time, and network. See .
4. Configure Windows®. We recommend to:
  - Update Windows® to the latest version. See .
  - Create a standard user account. See .
5. Update AXIS Camera Station Pro to the latest version.
  - If your system is online: open the AXIS Recorder Toolbox app and click **Update AXIS Camera Station**.
  - If your system is offline: go to *axis.com* and download the latest version.
6. Start the AXIS Camera Station Pro client.
7. *Connect to AXIS Camera Station Pro server*
- 8.

# AXIS Camera Station S2208 Mk II Appliance

## Install your device

### Install your device

For instructions on how to install the product, see the installation guide included in the box or on the product's support page on [axis.com](http://axis.com).

### Setup examples

#### Setup in an independent surveillance network

You can create an independent surveillance network which has no interconnectivity to another external network. This setup is a basic plug and play installation. The built-in switch's DHCP server is enabled by default. As soon as you plug the cameras into the PoE ports, the cameras will power on and obtain an IP address and be accessible via AXIS Camera Station Pro.

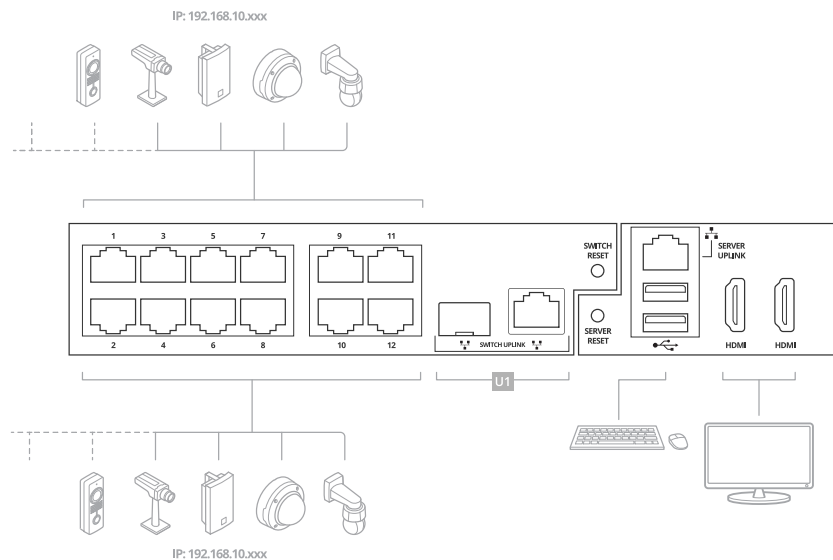

Difficulty level	Basic
Benefits	Dedicated surveillance network with no interconnectivity to another external network Plug and play installation
Limitations	Bandwidth PoE budget No remote access
Actions needed	Change the default password for the built-in switch Register the AXIS Camera Station Pro license
Connectors used	PoE Ethernet ports USB 2.0 ports (for keyboard and mouse) Displayport™ or HDMI connector
Connectors NOT used	Switch uplink port Server uplink port USB 3.2 port (front side) Universal audio jack (front side)

#### Setup in an existing network

You can create a surveillance network within an existing network. This means that the surveillance network is separated from the existing network.

# AXIS Camera Station S2208 Mk II Appliance

## Install your device

### Note

When you use an additional recorder, for example, the AXIS S30 Recorders, the appliance does not route network data from the surveillance network to the server network for recording. Make sure that the AXIS S30 Recorders are connected to the same network as the cameras.

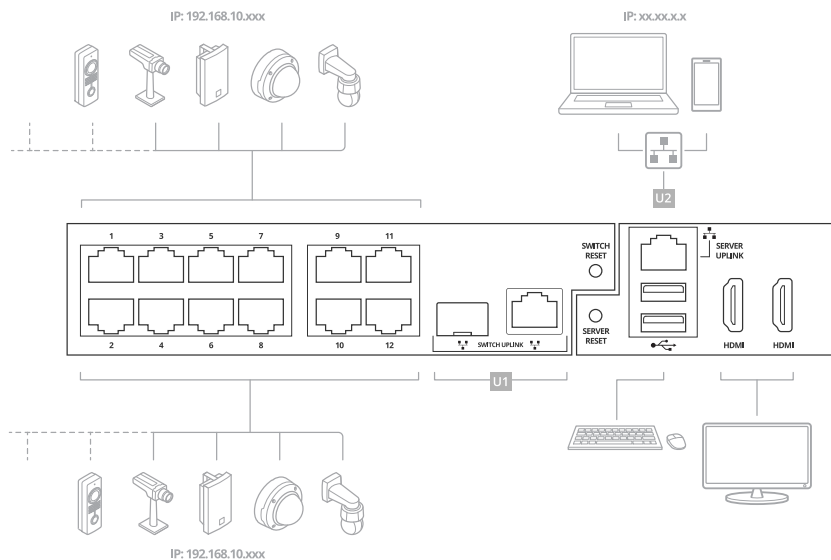

Difficulty level	Advanced
Benefits	Ability to use an AXIS Camera Station Pro client to connect to S22 series over the network. Network segregation
Limitations	May require you to follow corporate network policies
Actions needed	Change the default password for the built-in switch Register the AXIS Camera Station Pro license
Connectors used	PoE Ethernet ports Ethernet port – Server uplink for connection to network (Optional) USB 2.0 ports (for keyboard and mouse) (Optional) Displayport™ or HDMI connector
Connectors NOT used	Switch uplink port USB 3.2 port (front side) Universal audio jack (front side)

### Connect the switch directly to the corporate network

This setup integrates the system directly into your existing corporate network, allowing cameras to be accessed and monitored from anywhere on the network.

# AXIS Camera Station S2208 Mk II Appliance

## Install your device

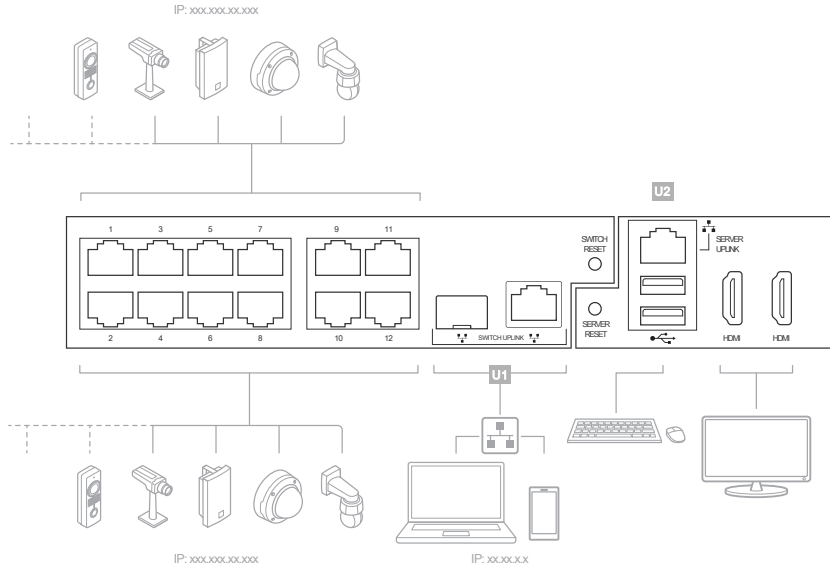

Difficulty level	Advanced
Benefits	Cameras are accessible from the corporate network and can be monitored with an SNMP server.
Limitations	May require you to follow corporate network policies
Actions needed	Turn off DHCP on the switch Change the switch's IP address to a static one from the corporate network Set the PC's internal NIC to DHCP or a static IP on the corporate network Change the switch's default password. Configure and register AXIS Camera Station Pro
Connectors used	PoE Ethernet ports Switch uplink port (U1) (Optional) USB 2.0 ports (for keyboard and mouse) (Optional) Displayport™ or HDMI connector
Connectors NOT used	PC uplink port (U2) USB 3.2 port (front side) Universal audio jack (front side)

# AXIS Camera Station S2208 Mk II Appliance

## Configure your device

---

### Configure your device

#### Initial Axis recorder setup

After you have configured Windows®, AXIS Recorder Toolbox is opened automatically and you are guided through the first-time configuration setup assistant. In this setup assistant, you can configure several basic and necessary settings before you manage your device in AXIS Recorder Toolbox.

##### Note

The settings are for the server. To change the switch's settings, go to the switch's management page. See .

1. Select **Light** or **Dark** theme and click **Next** (if it's available for your product).
2. Change the computer name if you want and click **Next**.
3. Under **Date and time**, configure the following settings and click **Next**.
  - Select a time zone.
  - To set up an NTP server, select **NTP server** and enter the NTP server address.
  - To set manually, select **Manual** and select a date and time.
4. Under **Network settings**, configure the following settings and click **Next**.
  - **Use automatic IP settings (DHCP)** and **Use automatic DNS settings** are turned on by default.
  - If your device is connected to a network with a DHCP server, the assigned IP address, subnet mask, gateway, and preferred DNS are automatically displayed.
  - If your device is not connected to a network or there is no DHCP server available, enter the IP address, subnet mask, gateway, and preferred DNS manually depending on the network requirements.
5. Click **Finish**. If you have changed the computer name, AXIS Recorder Toolbox will prompt you to restart the device.

#### Log in to the server

Using the AXIS Camera Station Pro client, you can connect to multiple servers or a single server installed on the local computer or somewhere else on the network. You can connect to AXIS Camera Station Pro servers in different ways:

**Last used servers** – Connect to the servers used in the previous session.

**This computer** – Connect to the server installed on the same computer as the client.

**Remote server** – See .

**AXIS Secure Remote Access** – See .

##### Note

When trying to connect to a server for the first time, the client checks the server certificate ID. To ensure that you're connecting to the correct server, manually verify the certificate ID with the one displayed in AXIS Camera Station Pro Service Control.

Server list	To connect to servers from a server list, select a one from the <b>Server list</b> drop-down menu. Click  to create or edit the server lists.
Import server list	To import a server list file exported from AXIS Camera Station, click <b>Import server list</b> and browse to an .msl file.

# AXIS Camera Station S2208 Mk II Appliance

## Configure your device

---

Delete saved passwords	To delete saved usernames and passwords all connected servers, click <b>Delete saved passwords</b> .
Change client proxy settings	You might need to change the client proxy settings to connect to a server, click <b>Change client proxy settings</b> .

### Log in on a remote server

1. Select Remote server.
2. Select a server from the **Remote server** drop-down list or enter the IP or DNS address. If the server isn't listed, click  to reload all the available remote servers. If the server is configured to accept clients on a different port than the default port number 55752, enter the IP address followed by the port number, for example, 192.168.0.5:46001.
3. You can:
  - Select **Log in as current user** to log in as the current Windows® user.
  - Clear **Log in as current user** and click **Log in**. Select **Other user** and provide another username and password to log in with a different username and password.

### Sign in to AXIS Secure Remote Access

#### Note

- When trying to connect to a server using Axis Secure Remote Access, the server can't upgrade the client automatically.
- If the proxy server is between the network device and the AXIS Camera Station S2208 Mk II Appliance server, you must configure the proxy settings in Windows on the AXIS Camera Station S2208 Mk II Appliance server to access the server using AXIS Secure Remote Access.

1. Click the **Sign in to AXIS Secure Remote Access** link.
2. Enter your My Axis account credentials.
3. Click **Sign in**.
4. Click **Grant**.

### Configure AXIS Camera Station Pro

This tutorial will walk you through the basic steps to make your system up and running.

Before you start:

- Configure your network depending on your installation. See .
- Configure your server ports if needed. See .
- Consider security issues. See .

After necessary configurations, you can start to work with AXIS Camera Station Pro:

- 1.
- 2.
- 3.
- 4.
- 5.



# AXIS Camera Station S2208 Mk II Appliance

## Configure your device

---

- 6.
- 7.
- 8.

### Start the video management system

Double-click the AXIS Camera Station Pro client icon to start the client. When you start the client for the first time, it attempts to log in to the AXIS Camera Station Pro server installed on the same computer as the client.

You can connect to multiple AXIS Camera Station Pro servers in different ways.

### Add devices

The Add devices page opens the first time you start AXIS Camera Station Pro. AXIS Camera Station Pro searches the network for connected devices and shows a list of devices found.

1. Select the cameras you want to add from the list. If you can't find your camera, click **Manual search**.
2. Click **Add**.
3. Select **Quick configuration** or **Site Designer configuration**. Click **Next**.
4. Use the default settings and ensure the recording method is **None**. Click **Install**.

### Configure recording method

1. Go to **Configuration > Recording and events > Recording method**.
2. Select a camera.
3. Turn on **Motion detection**, or **Continuous**, or both.
4. Click **Apply**.

### View live video

1. Open a **Live view** tab.
2. Select a camera to view its live video.

### View recordings

1. Open a **Recordings** tab.
2. Select the camera you want to view recordings from.

### Add bookmarks

1. Go to the recording.
2. In the timeline of the camera, zoom in and out and move the timeline to put the marker at your desired position.
3. Click  .
4. Enter the bookmark name and description. Use keywords in the description to make the bookmark easy to find and recognize.
5. Select **Prevent recording deletion** to lock the recording.

# AXIS Camera Station S2208 Mk II Appliance

## Configure your device



---

### Note

It's not possible to delete a locked recording. To unlock the recording, clear the option or delete the bookmark.

6. Click OK to save the bookmark.

### Export recordings

1. Open a Recordings tab.
2. Select the camera you want to export recordings from.
3. Click  to display the selection markers.
4. Drag the markers to include the recordings that you want to export.
5. Click  to open the Export tab.
6. Click Export....

### Play and verify recordings in AXIS File Player

1. Go to the folder with the exported recordings.
2. Double-click AXIS File Player.
3. Click  to show the recording's notes.
4. To verify the digital signature:
  - 4.1 Go to Tools > Verify digital signature.
  - 4.2 Select Validate with password and enter your password.
  - 4.3 Click Verify. The verification result page appears.

### Note

Digital signature is different from Signed video. Signed video allows you to trace video back to the camera it came from, making it possible to verify that the recording wasn't tampered with. See *Signed video* and the camera's user manual for more information.

### Network configuration

Configure proxy or firewall settings before using AXIS Camera Station Pro if the AXIS Camera Station Pro client, AXIS Camera Station Pro server, and the connected network devices are on different networks.

#### Client proxy settings

If the proxy server is between the client and the server, you must configure the proxy settings in Windows on the client computer.

#### Server proxy settings

If the proxy server is between the network device and the server, you must configure the proxy settings in Windows on the server.

#### NAT and Firewall

When a NAT, firewall, or similar separates the client and the server, configure the NAT or firewall to ensure that the HTTP port, TCP port, and streaming port specified in AXIS Camera Station Service Control can pass through the firewall or NAT. Contact the network administrator for instructions on configuring the NAT or firewall.

# AXIS Camera Station S2208 Mk II Appliance

## Configure your device

---

### Server port configuration

AXIS Camera Station Pro server uses ports 55752 (HTTP), 55754 (TCP), 55756 (mobile communication), and 55757 (mobile streaming) for communication between the server and the client. You can change the ports in AXIS Camera Station Service Control if required.

### Security considerations

To prevent unauthorized access to cameras and recordings, keep the following in mind:

- Use strong passwords for all network devices (cameras, video encoders, and auxiliary devices).
- Install AXIS Camera Station S2208 Mk II Appliance server, cameras, video encoders, and auxiliary devices on a secure network separate from the office network. You can install the AXIS Camera Station S2208 Mk II Appliance client on a computer on another network, for example, a network with internet access.
- Make sure all users have strong passwords. Windows® Active Directory provides a high level of security.

### License a system online

To use automatic licensing, you must register your system and connect it to an organization.

1. Go to **Configuration > Licenses > Management**.
2. Make sure **Automatic licensing** is on.
3. Click **Register...**
4. Sign in using your My Axis account and follow the onscreen instructions.
5. Click **Go to AXIS License Manager** to manage your licenses there. Read the *My Systems user manual on help.axis.com* for more information.

### License a system that's offline

To license your system manually:

1. Go to **Configuration > Licenses > Management**.
2. Turn off **Automatic licensing**.
3. Click **Export system file...** and save the file to your computer.

#### Note

You must have an internet connection to access AXIS License Manager. If your client computer doesn't have internet, copy the system file to a computer that does.

4. Open *AXIS License Manager*.
5. In *AXIS License Manager*:
  - 5.1 Select the correct organization, or create one if you haven't already. Read the *My Systems user manual on help.axis.com* for more information.
  - 5.2 Go to **System setup**.
  - 5.3 Click **Upload system file**.
  - 5.4 Click **Upload system file** and select your system file.
  - 5.5 Click **Upload system file**.
  - 5.6 Click **Download license file**.

# AXIS Camera Station S2208 Mk II Appliance

## Configure your device

---

6. Go back to the AXIS Camera Station S2208 Mk II Appliance client.
7. Click **Import license file...** and select your license file.
8. Click **Go to AXIS License Manager** to manage your licenses there.

# AXIS Camera Station S2208 Mk II Appliance

## Manage Windows® user accounts

---

### Manage Windows® user accounts

#### Create a user account

To help keep your personal data and information more secure, we recommend that you add a password for each local account.

##### Important

Once you create a password for a local account, don't forget it. There's no way to recover a lost password for local accounts.

1. Go to **Settings > Accounts > Other users > Add other user** and click **Add account**.
2. Click **I don't have this person's sign-in information**.
3. Click **Add a user without a Microsoft account**.
4. Enter a user name, password and password hint.
5. Click **Next** and follow the instructions.

#### Create an administrator account

1. Go to **Settings > Accounts > Other people**.
2. Go to the account you want to change and click **Change account type**.
3. Go to **Account type** and select **Administrator**.
4. Click **OK**.
5. Restart your device and sign in with the new administrator account.

#### Create a local user group

1. Go to **Computer Management**.
2. Go to **Local Users and Groups > Group**.
3. Right-click **Group** and select **New Group**.
4. Enter a group name and a description.
5. Add group members:
  - 5.1 Click **Add**.
  - 5.2 Click **Advanced**.
  - 5.3 Find the user account(s) you want to add to the group and click **OK**.
  - 5.4 Click **OK** again.
6. Click **Create**.

#### Delete a user account

##### Important

When you delete an account you remove the user account from the login screen. You also remove all files, settings and program data stored on the user account.

# AXIS Camera Station S2208 Mk II Appliance

## Manage Windows® user accounts

---

1. Go to **Settings > Accounts > Other people**.
2. Go to the account you want to remove and click **Remove**.

### Change a user account's password

1. Log in with an administrator account.
2. Go to **User Accounts > User Accounts > Manage another account in sequence**.  
You'll see a list with all user accounts on the device.
3. Select the user account whose password you would like to change.
4. Click **Change the password**.
5. Enter the new password and click **Change password**.

### Create a password reset disk for a user account

We recommend to create a password reset disk on a USB flash drive. With this, you can reset the password. Without a password reset disk, you can't reset the password.

#### Note

If you're using Windows® 10, or later, you can add security questions to your local account in case you forget your password, so you don't need to create a password reset disk. To do this, go to **Start** and click **Settings > Sign-in options > Update your security questions**.

1. Sign in to your device with a local user account. You can't create a password reset disk for a connected account.
2. Plug an empty USB flash drive into your device.
3. From the Windows® search field, go to **Create a password reset disk**.
4. In the **Forgotten Password** setup assistant, click **Next**.
5. Select your USB flash drive and click **Next**.
6. Type your current password and click **Next**.
7. Follow the onscreen instructions.
8. Remove the USB flash drive and keep it in a safe place. You don't have to create a new disk when you change your password even if you change it several times.

# AXIS Camera Station S2208 Mk II Appliance

## Manage AXIS Camera Station Pro user accounts

---

### Manage AXIS Camera Station Pro user accounts

#### Configure user permissions



Go to **Configuration > Security > User permissions** to view the users and groups that exists in AXIS Camera Station S2208 Mk II Appliance.

##### Note

Administrators of the computer that runs AXIS Camera Station S2208 Mk II Appliance server are automatically given administrator privileges to AXIS Camera Station S2208 Mk II Appliance. You can't change or remove the Administrators group's privileges.

Before you can add a user or group, register the user or group on the local computer or make sure they have an Windows® Active Directory user account. To add users or groups, see .

When a user is part of a group, the user gets the highest role permission assigned to the individual or the group. The user also gets the access granted as an individual and receives the rights as part of a group. For example, a user has access to camera X as an individual. The user is also a member of a group that has access to cameras Y and Z. The user therefore has access to cameras X, Y, and Z.

	Indicates the entry is a single user.
	Indicates the entry is a group.
<b>Name</b>	Username as it appears in the local computer or Active Directory.
<b>Domain</b>	The domain that the user or group belongs to.
<b>Role</b>	The access role given to the user or group. Possible values: Administrator, Operator, and Viewer.
<b>Details</b>	Detailed user information as it appears in the local computer or Active Directory.
<b>Server</b>	The server that the user or group belongs to.

#### Add users or groups

Microsoft Windows® and Active Directory users and groups can access AXIS Camera Station S2208 Mk II Appliance. To add a user to AXIS Camera Station S2208 Mk II Appliance, you must add users or a group to Windows®.

To add a user in Windows® vary depending on which version of Windows® you use. Follow the instructions on *Microsoft's site*. If you use an Active Directory domain network, consult your network administrator

##### Add users or groups

1. Go to **Configuration > Security > User permissions**.

2. Click **Add**.

You can see the available users and groups in the list.

3. Under **Scope**, select where to search for users and groups.

4. Under **Show**, select to show users or groups.

The search result doesn't display if there are too many users or groups. Use the filter function.

5. Select the users or groups and click **Add**.

# AXIS Camera Station S2208 Mk II Appliance

## Manage AXIS Camera Station Pro user accounts

---

Scope	
Server	Select to search for users or groups on the local computer.
Domain	Select to search for Active Directory users or groups.
Selected server	When connected to multiple AXIS Camera Station S2208 Mk II Appliance servers, select a server from the Selected server drop-down menu.

### Configure a user or group

1. Select a user or group in the list.
2. Under **Role**, select **Administrator**, **Operator**, or **Viewer**.
3. If you selected **Operator** or **Viewer**, you can configure the user or group privileges. See .
4. Click **Save**.

### Remove a user or group

1. Select the user or group.
2. Click **Remove**.
3. In the pop-up dialog, click **OK** to remove the user or group.

## User or group privileges

There are three roles you can give to a user or group. For how to define the role for a user or group, see .

**Administrator** - Full access to the entire system, including access to live and recorded video of all cameras, all I/O ports, and views. This role is required to configure anything in the system.

**Operator** - Select cameras, views, and I/O ports to get access to live and recorded. An operator has full access to all functionality of AXIS Camera Station S2208 Mk II Appliance except system configuration.

**Viewer** - Access to live video of selected cameras, I/O ports, and views. A viewer doesn't have access to recorded video or system configuration.

### Cameras

The following access privileges are available for users or groups with the **Operator** or **Viewer** role.

Access	Allow access to the camera and all camera features.
Video	Allow access to live video from the camera.
Audio listen	Allow access to listen from the camera.
Audio speak	Allow access to speak to the camera.
Manual Recording	Allow to start and stop recordings manually.
Mechanical PTZ	Allow access to mechanical PTZ controls. Only available for cameras with mechanical PTZ.
PTZ priority	Set the PTZ priority. A lower number means a higher priority. No assigned priority is set to 0. An administrator has the highest priority. When a role with higher priority operates a PTZ camera, others can't operate the same camera for 10 seconds by default. Only available for cameras with mechanical PTZ and have <b>Mechanical PTZ</b> selected.



# AXIS Camera Station S2208 Mk II Appliance

## Manage AXIS Camera Station Pro user accounts

---

### Views

The following access privileges are available for users or groups with the **Operator** or **Viewer** role. You can select multiple views and set the access privileges.

Access	Allow access to the views in AXIS Camera Station S2208 Mk II Appliance.
Edit	Allow to edit the views in AXIS Camera Station S2208 Mk II Appliance.

### I/O

The following access privileges are available for users or groups with the **Operator** or **Viewer** role.

Access	Allow full access to the I/O port.
Read	Allow to view the state of the I/O port. The user can't change the port state.
Write	Allow to change the state of the I/O port.

### System

You can't configure greyed out access privileges in the list. Privileges with check mark means the user or group have this privilege by default.

The following access privileges are available for users or groups with the **Operator** role. **Take snapshots** is also available for the **Viewer** role.

Take snapshots	Allow to take snapshots in the live view and recordings modes.
Export recordings	Allow to export recordings.
Generate incident report	Allow to generate incident reports.
Prevent access to recordings older than	Prevent access to recordings older than the specified number of minutes. When using search, the user doesn't find recordings older than the specified time.
Access alarms, tasks, and logs	Get alarm notifications and allow access to the <b>Alarms and tasks</b> bar and <b>Logs</b> tab.
Access data search	Allow searching for data to track what happened at the time of an event.

### Access control

The following access privileges are available for users or groups with the **Operator** role. **Access Management** is also available for the **Viewer** role.

Access control configuration	Allow configuration of doors and zones, identification profiles, card formats and PIN, encrypted communication, and multi-server.
Access management	Allow access management and access to the active directory settings.

### System health monitoring

The following access privileges are available for users or groups with the **Operator** role. **Access to system health monitoring** is also available for the **Viewer** role.

# AXIS Camera Station S2208 Mk II Appliance

## Manage AXIS Camera Station Pro user accounts

---

Configuration of system health monitoring	Allow configuration of the system health monitoring system.
Access to system health monitoring	Allow access to the system health monitoring system.

# AXIS Camera Station S2208 Mk II Appliance

## Manage your device

---

### Manage your device

#### Update Windows®

Windows® periodically checks for updates. When an update is available, your device automatically downloads the update but you've to install it manually.

##### Note

Recording will be interrupted during a scheduled system restart.

To manually check for updates:

1. Go to **Settings > Windows Update**.
2. Click **Check for updates**.

#### Configure Windows® update settings

It is possible to change how and when Windows® do its updates to suit your needs.

##### Note

All ongoing recordings stop during a scheduled system restart.

1. Open the Run app.
  - Go to **Windows System > Run**, or
2. Type `gpedit.msc` and click **OK**. The Local Group Policy Editor opens.
3. Go to **Computer Configuration > Administrative Templates > Windows Components > Windows Update**.
4. Configure the settings as required, see example.

##### Example:

To automatically download and install updates without any user interaction and have the device restart, if necessary, at out of office hours, use the following configuration:

5. Open **Always automatically restart at the scheduled time** and select:
  - 5.1 **Enabled**
  - 5.2 **The restart timer will give users this much time to save their work (minutes): 15.**
  - 5.3 **Click OK.**
6. Open **Configure Automatic Updates** and select:
  - 6.1 **Enabled**
  - 6.2 **Configure Automatic updates: Auto download and schedule the install**
  - 6.3 **Schedule Install day: Every Sunday**
  - 6.4 **Schedule Install time: 00:00**
  - 6.5 **Click OK.**
7. Open **Allow Automatic Updates immediate installation** and select:
  - 7.1 **Enabled**

# AXIS Camera Station S2208 Mk II Appliance

## Manage your device

---

7.2 Click OK.

### Add additional storage

The demand for storage can differ. Retention time of stored data or for storing high-resolution recordings often results in a need to install more storage. This section explains how to install an additional hard drive in your AXIS S22 series product.

#### Note

Follow the instructions below to add additional storage to applicable AXIS S22 products. These instructions are as-is, and Axis Communications AB takes no responsibility for loss of data or misconfiguration during these steps. The standard precautions should be taken to backup data that is business critical. The following procedure of expanding storage will not be supported by Axis Technical Support.

#### Note

To avoid electrostatic discharge, we recommend that you always use a static mat and static strap while working on internal system components.

#### Warranty

Detailed information about warranty is available at: [www.axis.com/support/warranty](http://www.axis.com/support/warranty).



To watch this video, go to the web version of this document.  
[help.axis.com/?tptid=90757&tsection=add-an-additional-storage](http://help.axis.com/?tptid=90757&tsection=add-an-additional-storage)

### Remove the bezel

1. Loosen the two thumbscrews located at each side of the bezel.
2. Remove the bezel.

### Install the hard drive

#### ⚠CAUTION

- Use only hard drives that have been tested and approved for use with AXIS S22 series.
- When you install a hard drive, make sure that the hard drive carrier is pushed all the way in. You will hear a click when the drive carrier is locked.
- Before you install a hard drive, make sure the power cord is disconnected.

1. Shut down the system and make sure the power is off.
2. Disconnect the power cord.
3. Press the release button on the front of the hard drive carrier and open the hard drive carrier handle.
4. Pull out the hard drive carrier using the handle.
5. Insert a hard drive in the hard drive carrier.

# AXIS Camera Station S2208 Mk II Appliance

## Manage your device

---

6. Fasten the hard drive to the hard drive carrier with four screws.
7. Insert the hard drive carrier into the hard drive slot until the carrier connects with the backplane.
8. Close the hard drive carrier handle to lock the hard drive in place.
9. Reattach the front bezel.
10. Start the system.

### Add a new recording storage

1. Create and format a new hard disk partition in Windows.
  - 1.1 Click the Start button and type **Create and format hard disk partitions** in the search bar. Select the result to open the Disk Management tool.
  - 1.2 Click **OK** if the **Initialize Disk** popup appears. If it doesn't, right-click on the new hard drive and select **Initialize Disk**.
  - 1.3 Right-click on an unallocated region on the newly initialized disk and select **New Simple Volume**.
  - 1.4 Follow the wizard to set the volume size, assign a drive letter, and format the partition.
  - 1.5 Complete the wizard to create the new simple volume.
2. Add a new recording storage in Axis Camera Station Pro.
  - 2.1 Open Axis Camera Station Pro.
  - 2.2 Go to **Storage > Management**
  - 2.3 Click **Add...**
  - 2.4 Select the newly added drive and click **OK**.
  - 2.5 Go to **Storage > Selection**
  - 2.6 Select which devices you want to transfer recording data to the new drive.
  - 2.7 In the **Store to** drop-down list, select the new drive and click **Apply**.

For more information about storage management, see *Axis Camera Station Pro – User manual*.

# AXIS Camera Station S2208 Mk II Appliance

## Manage the built-in switch

---

### Manage the built-in switch

#### About the built-in switch

The AXIS Camera Station S22 Mk II Appliance Series comes with an integrated Power over Ethernet (PoE) switch. You can configure and manage the built-in switch.

The purpose of the switch is to segregate traffic on the network so that security cameras and related traffic managed by the switch (PoE and the switch uplink ports) are not shared with other networks.

The switch's power management follows these rules:

- Each port can reserve power according to the connected powered device's PoE class. You can also manually allocate power to a port.
- If the actual power consumption for a given port exceeds the reserved power for that port, it will shut down.
- Ports will shut down when the actual power consumption for all ports exceeds the total amount of power that the power supply can deliver. The ports are then shut down according to the ports priority where a lower port number means higher priority.

#### Log in to the switch's management page

1. Go to the menu bar.
  - From the web browser, enter the switch's IP address. By default: 192.168.10.1
  - From AXIS Recorder Toolbox, go to **Switch > Open the switch configuration**.
2. Log in with your username and password.
  - Your username is `admin`
  - Your password is located on a sticker that's either placed on the device or included in the box content as a self-adhesive sticker.

Log out from the menu bar to exit the switch's management page.

#### Running configuration

The running configuration is the set of settings that are currently active and operational on your network device. It reflects your device's current state and how it's functioning in real time. However, these changes aren't saved if your device reboots.

In contrast, the startup configuration is the set of settings that are saved on your device's non-volatile memory. This configuration is loaded and applied when your device starts up or restarts.

When you make changes in the web interface and click **Save**, those changes are applied to the running configuration.

To save your settings to the startup configuration, use the **Save** icon in the upper-right corner of the web interface.

If there are unsaved changes in the running configuration, the icon will flash yellow.

#### Overview

In the menu bar, click **Overview**.

##### General information

# AXIS Camera Station S2208 Mk II Appliance

## Manage the built-in switch

Category	Item	Description
Ports summary	Active ports	The number of ports in use.
	Ports using PoE	The number of PoE-enabled ports in use.
	Locked ports	The number of locked ports.
Power consumption	Current PoE usage	The PoE power in watts consumed by devices and the percentage of consumed PoE power out of the total dedicated PoE power.
	Power requested	The total power in watts and percentage allocated to devices.
Port status	Active	The port is in use.
	Inactive	The port is ready to be used.
	Blocked	The port is blocked.

### Note

You can click on a port to view more information about it.

## Power management

In the menu bar, click **Power management**.

### Port list

Item	Description
Port	The port number that the device is connected to.
PoE	The PoE status. You can click the icon to turn on or turn off PoE on the port.
PoE class	The PoE class of the connected device.
Priority	The priority of power allocation to the connected device. By default, the priority is the port number.
Power consumption (W)	The power in watts consumed by the device connected to the port.
Power requested (W)	The power in watts requested by the device connected to the port.
Power allocated (W)	Manually adjust the power allocated to the port. Only available when you select <b>Manual</b> as the power allocation method.

## Allocate power

PoE power can be allocated to the connected devices in the following ways:

- **PoE class:** The switch allocates PoE power based on the PoE class of the connected device.
- **Manual:** You can manually adjust PoE power allocated to the connected device.
- **LLDP-MED:** The switch communicates with the connected device and dynamically allocates PoE power as needed.

### Note

The LLDP-MED power allocation method only works for cameras with AXIS OS 9.20 or later.

To change the power allocation method:

1. In the switch's power management page, go to **Power management**.
2. Select **PoE class**, **Manual**, or **LLDP-MED** under **Allocate power**

# AXIS Camera Station S2208 Mk II Appliance

## Manage the built-in switch

3. If you have selected **Manual**, you can change the power allocated to the connected device in the **Power allocated** column.
4. If you want to change the priority of the connected device, select a priority for that device. The priority of other devices will change automatically.

### Example:

In this example, the switch has a total power budget of 135 W. A PoE class 4 device requests 30 W power but only consumes 15 W. A PoE class 2 device requests 7 W power but only consumes 5 W power.

### Allocate power by PoE class

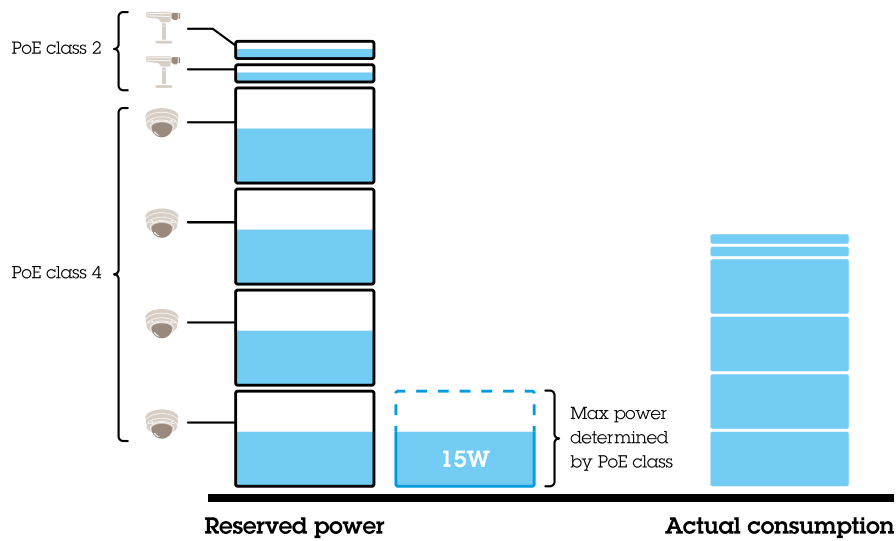

The power requested by each device is determined by the PoE class. The switch can power 4 PoE class 4 devices and 2 PoE class 2 devices. The total power requested is  $(4 \times 30) + (2 \times 7) = 134$  W. The actual power consumed is  $(4 \times 15) + (2 \times 5) = 70$  W. In this way, all connected devices are guaranteed enough power and the priority is less important.

### Allocate power manually

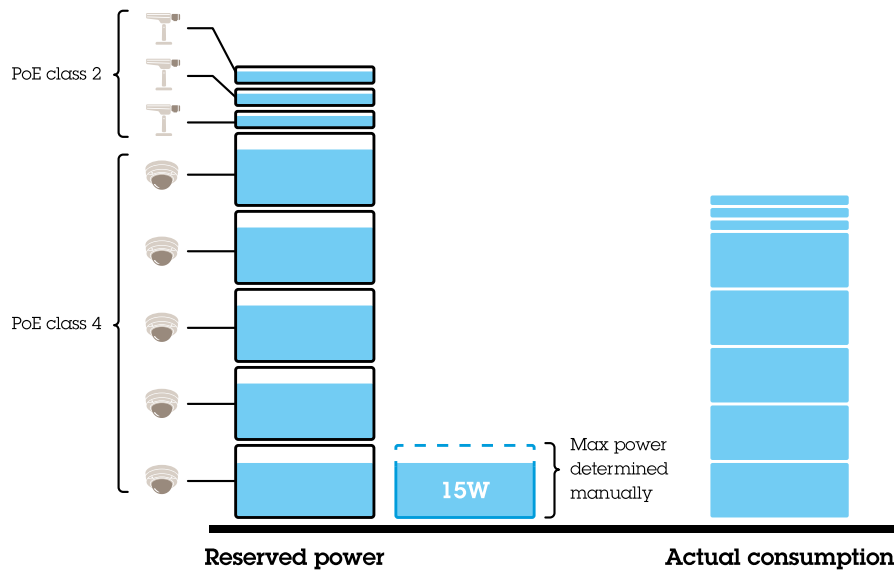



# AXIS Camera Station S2208 Mk II Appliance

## Manage the built-in switch

---

The power requested is manually adjusted to 20 W for PoE class 4 devices. The switch can power 5 PoE class 4 devices and 3 PoE class 2 devices. The total power requested is  $(5 \times 20) + (3 \times 7) = 121$  W. The actual power consumed is  $(5 \times 15) + (3 \times 5) = 90$  W. In this way, all connected devices are guaranteed enough power and the priority is less important.

### Turn on and turn off PoE

#### Turn on PoE on a port

1. In the menu bar, click **Overview**.
2. In the PoE column, click  to turn on PoE on the specific port.

#### Turn off PoE on a port

1. In the menu bar, click **Overview**.
2. In the PoE column, click  to turn off PoE on the specific port.

#### Turn on and turn off PoE on all ports

1. In the menu bar, click **Power management**.
2. To turn off PoE on all ports, go to the **PoE ports state** drop-down menu and select **Turn off all**.
3. To turn on PoE on all ports, go to the **PoE ports state** drop-down menu and select **Turn on all**.

## Network overview

The network overview provides detailed information about the network traffic status of each port.

### PoE ports

Item	Description
Port	The port number that the device is connected to.
Device	The name of the device connected to the port.
IP address	The IP address of the device connected to the port.
MAC address	The MAC address of the device connected to the port.
Receive	The current data rate in megabits per second for inbound data on the port.
Transmit	The current data rate in megabits per second for outbound data on the port.
Packet sent	The number of data packets that the switch has transmitted to the network.
Packet received	The number of data packets that the switch has received from the network.
Packet lost	The number and percentage of data packets that failed to reach their destination due to network issues.
Lock	Displays whether the port is locked. You can click the icon to lock or unlock the port.

### Lock and unlock ports

You can lock a MAC address to a port so that only traffic coming from that MAC address will pass. This improves security and prevents unauthorized users from connecting a laptop or other devices to the security network.

#### Lock a MAC address to a port

1. In the menu bar, click **Network overview**.

# AXIS Camera Station S2208 Mk II Appliance

## Manage the built-in switch

---

2. In the **Lock** column, click  to lock the specific port.

### Unlock a MAC address from a port

1. In the menu bar, click **Network overview**.
2. In the **Lock** column, click  to unlock the specific port.

### Lock or unlock all ports

1. In the menu bar, click **Network overview**.
2. To lock all ports, go to the **Lock ports** drop-down menu and select **Lock all**.
3. To unlock all ports, go to the **Lock ports** drop-down menu and select **Unlock all**.

## Settings

### Configure network settings

You can change the switch's IP address. But for most camera installations, we recommend using the default settings. The reason for this is that a surveillance network is normally isolated from other networks, for example a corporate LAN. In this case, you would only use the surveillance network to manage and collect surveillance devices and data from the video management software installed on the server.

1. In the menu bar, go to **Settings > Network settings**.
2. Enter the connection type, IP address, subnet mask, gateway, primary DNS, secondary DNS, and hostname.

#### Note

The factory default settings are: a static IP connection with address 192.168.10.1 and a subnet mask with address 255.255.255.0.

3. Click **Save**.

### Configure date and time

1. In the menu bar, go to **Settings > Date and time**.
2. Select the country and time zone.
3. To set the time manually, select **Manual** and manually adjust the time.
4. To set up an NTP server, select **NTP server** and enter the NTP server address.

#### Note

NTP only works when the switch is connected to a network and configured with Internet access.

5. Click **Save**.

### Configure DHCP server

You can configure the switch to use its internal DHCP server for assigning IP addresses to connected devices. When you use the switch uplink connection to allow devices to access or be accessed by external applications, you must specify the gateway and DNS addresses.

1. In the menu bar, go to **Settings > DHCP server**.
2. Select **Enable DHCP server**.

# AXIS Camera Station S2208 Mk II Appliance

## Manage the built-in switch

---

3. Enter the start IP address, end IP address, subnet mask, gateway, primary DNS, secondary DNS, lease length, and domain name.
4. Click **Save**.

### Configure SNMP

1. In the menu bar, go to **Settings > SNMP**.
2. Enter the server name, contact, and location used for the SNMP connection.
3. If you want to use SNMPV1 or SNMPV2c, select **SNMPV1 / SNMPV2c** and enter the read community.
4. If you want to use SNMPV3, select **SNMPV3 (MD5)** and enter the username and password.

#### Note

Currently we only support MD5 authentication used for SNMP.

5. Click **Save**.

## Maintenance

### Update firmware

1. In the menu bar, go to **Maintenance > Update firmware**.
2. Drag and drop the firmware file or click **Browse** and navigate to the firmware file.
3. Click **Upload**.
4. Once the firmware has been updated, reboot the switch.

### Reboot the switch

#### Important

While the switch reboots, all connected devices will temporarily lose connection with the switch including PoE.

1. In the menu bar, go to **Maintenance > Reboot switch**.
2. Click **Reboot** and **Yes**.
3. When the switch reboots after a few minutes, enter your username and password to log in.

### Backup the switch's settings

#### Note

The username and password are included in the backup file.

1. In the menu bar, go to **Maintenance > Backup and restore**.
2. Click **Create a backup file**. This creates a backup file in the .bin format and saves it in your **Downloads** folder.

### Restore the switch's settings

#### Note

To restore the switch's settings, you must previously have created a backup file.

1. In the menu bar, go to **Maintenance > Backup and restore**.

# AXIS Camera Station S2208 Mk II Appliance



## Manage the built-in switch

---

2. Drag and drop the backup file or click **Browse** and navigate to the backup file.
3. Click **Upload**.

It can take a few minutes to restore the switch from the backup file. Once the settings are restored, the switch will automatically reboot, and you will need to log in again.

### Manage certificates

1. In the menu bar, go to **Maintenance > Manage certificates**.
2. Click  and navigate to your private key file.
3. Click  and navigate to your certificate file.
4. Click  and navigate to your CA bundle file.
5. Click **Save**.
6. Reboot the switch.

### Change password

You can change the switch's default password to a password you choose yourself.

#### Important

Make sure to select a password you can remember. If you forget the password, see to restore the factory default password.

1. In the menu bar, go to **Maintenance > Change password**.
2. Enter the current password and your new password as required.
3. Click **Save**.

### Configure web settings

1. In the menu bar, go to **Maintenance > Web settings**.
2. Enter the port number.

#### Note

- If you decide to change the port number, make sure to write down the new port number. If you forget the new port number, see to restore the factory default port number.
- We recommend that you keep HTTPS enabled.

### Reset to factory default settings

Hold down the reset button for five seconds to reset the switch to its factory default settings.

You can also reset the switch through the web interface:

1. In the menu bar, go to **Maintenance > Reset to factory default settings**.
2. Click **Reset** and **Yes**.

After the reset is done, the switch will reboot automatically.

# AXIS Camera Station S2208 Mk II Appliance

## Manage the built-in switch

---

### Logs

In the menu bar, click **Logs** to see a list of logs. Click the column title to sort in alphabetical order.

Item	Description
Time	The date and time the log event occurred.
Level	The level of severity displayed as warning icons.
User	The user that initiated the log event.
IP address	The IP address of the user that initiated the log event.
Service	The service that the log event is related to. Possible values are desktop, network, network, system, ntpd, storage, dhcp, etc.
Event	A description of the log event.

### Create switch reports

In the log page, click **Export** to create a text file with switch information, including the log entries from the log page.

# AXIS Camera Station S2208 Mk II Appliance

## Specifications

### Specifications

#### Product overview

#### Front and rear

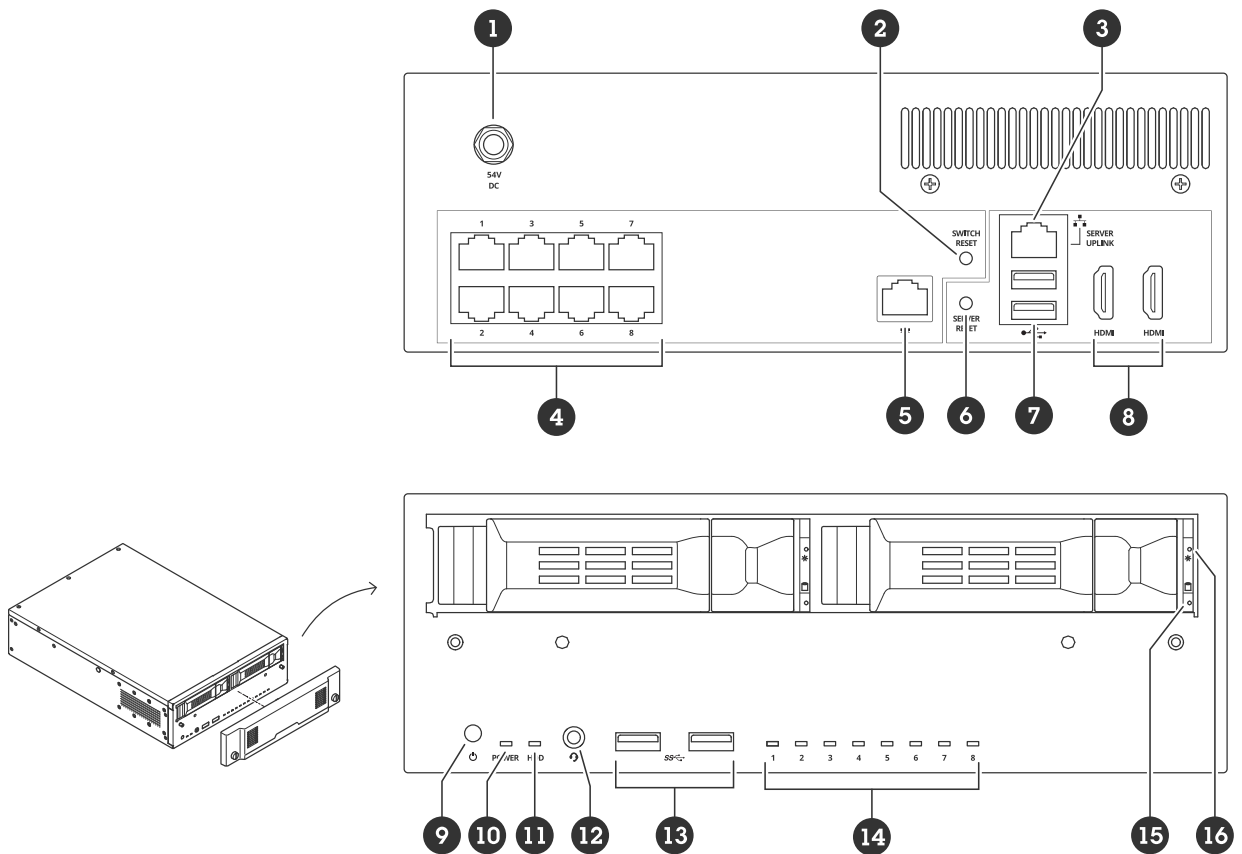

- 1 Power connector
- 2 Switch reset button
- 3 1 GbE Ethernet port – Server uplink
- 4 1 GbE PoE Ethernet ports
- 5 1 GbE Ethernet port – Switch uplink (RJ45)
- 6 Server reset button
- 7 USB 2.0 ports
- 8 HDMI ports
- 9 Power button
- 10 Power LED
- 11 Hard drive activity LED
- 12 Universal audio jack
- 13 USB 3.2 ports
- 14 PoE Ethernet ports status LED
- 15 Hard drive activity LED
- 16 Hard drive status LED

# AXIS Camera Station S2208 Mk II Appliance

## Specifications

---

### LED indicators

#### Front LEDs

Power button	Power LED	Indication
Not pressed	Off	PC and switch are off
	Amber	PC is on and switch is off
	Blinks amber	PC is on and switch is booting
	Green	PC is on and the switch has finished booting
Pressed	Up to 0 seconds	Powers on both the switch and PC if they are turned off
	Until it blinks amber (3 seconds)	Switch initiates graceful shutdown
	Until it blinks red (6 seconds)	PC and switch initiate graceful shutdown
	Until it turns solid red (9 seconds)	PC initiates ungraceful shutdown, switch initiates graceful shutdown

LED indicator	Color	Indication
Hard drive (HDD)	Blinks green	Hard drive activity
	Red	Possible hard drive failure
PoE Ethernet port status	Green	Link state
	Amber	Powered device, no link state
	Red	PoE budget exceeded
Hard drive status	Green	Hard drive present
	Red	Possible hard drive failure

#### Rear LEDs

Network speed and activity	Color	Indication
Right LED	Amber	10/100 Mbit/s
	Green	1000 Mbit/s
Left LED	Green	PoE connection OK
	Red	PoE budget exceeded

# AXIS Camera Station S2208 Mk II Appliance

## Troubleshooting

---

### Troubleshooting

#### Reset your server

You can use the server reset button to reset your server. It will take more than one hour to reset your server.

1. Power off your device.
2. Press and hold the server reset button for 5 seconds. Windows® RE will be started.
3. Select **Troubleshoot**.
4. Select **Reset your PC**.
5. Select **Keep my files** or **Remove everything**. If you select **Keep my files**, you need to provide the administrator credentials.
6. Follow the instructions on the screen.
7. The server reboots and starts the procedure to restore Windows® to factory default settings.



To watch this video, go to the web version of this document.

[help.axis.com/?Etpiald=90757&tsection=reset-your-server](http://help.axis.com/?Etpiald=90757&tsection=reset-your-server)

*Reset your server to factory default settings*

#### Perform a system recovery

If the device has had a complete system failure, you must use a recovery image to recreate the Windows® system. To download the AXIS Network Video Recorder Recovery Kit, contact Axis technical support and supply the serial number of your device.

1. Download the AXIS Network Video Recorder Recovery Kit and AXIS Network Video Recorder Recovery: ISO to USB Tool.
2. Insert a USB drive into your computer.
  - Use a USB drive with a minimum of 16 GB.
  - The USB drive will be formatted, and all existing data will be erased.
3. Run the AXIS Network Video Recorder Recovery: ISO to USB Tool and follow the onscreen instructions.

Writing data to the USB drive takes approximately 10 to 15 min. Don't remove the USB drive until the process is complete.
4. After the AXIS Network Video Recorder Recovery: ISO to USB Tool is complete, take the USB drive and plug it into your device.
5. Start your device.
6. When you see the Axis splash screen, press F12.
7. Click **UEFI: USB Drive**.
8. Navigate to your USB drive and press ENTER. The system boots into the AXIS Network Video Recorder Recovery Kit.



# AXIS Camera Station S2208 Mk II Appliance

## Troubleshooting

---

9. Click Reinstall Operating System.

The recovery takes roughly 10 to 15 min to complete. You find detailed instructions in the download for the recovery kit.

### Troubleshoot AXIS Camera Station Pro

For information about how to troubleshoot AXIS Camera Station Pro, go to the *AXIS Camera Station Pro user manual*.

# AXIS Camera Station S2208 Mk II Appliance

Need more help?

---

Need more help?

## Useful links

- *AXIS Camera Station Pro user manual*
- *Sign in to AXIS Secure Remote Access*
- *What to include in an Antivirus allowlist for AXIS Camera Station*

## Contact support

If you need more help, go to [axis.com/support](https://axis.com/support).

